

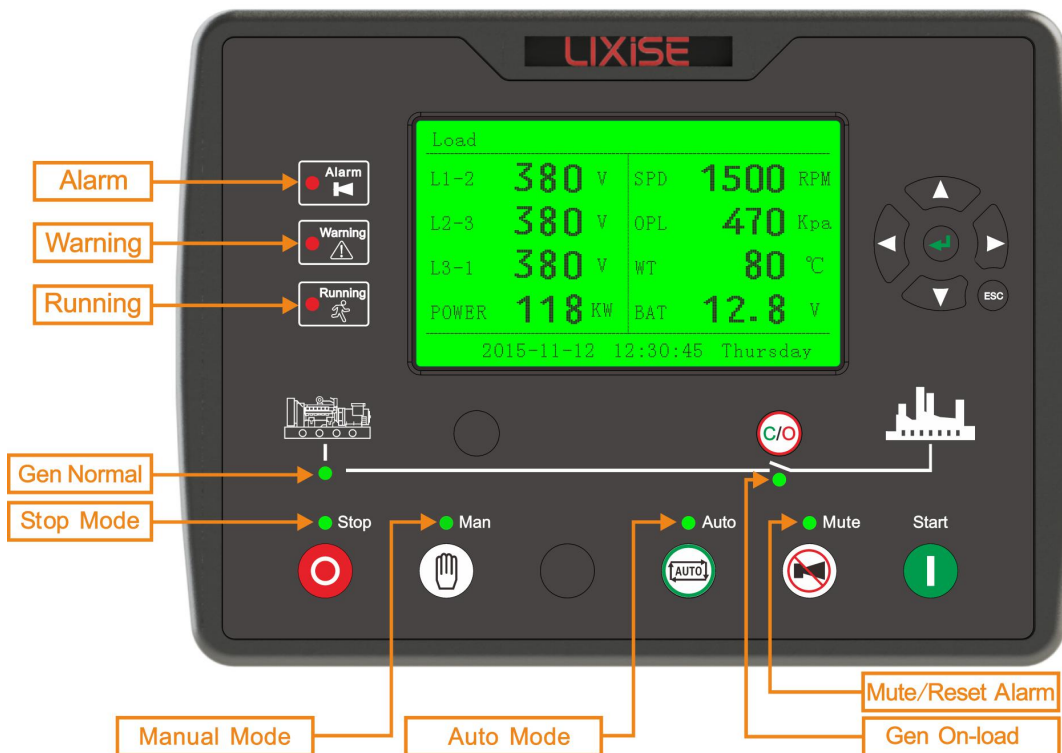

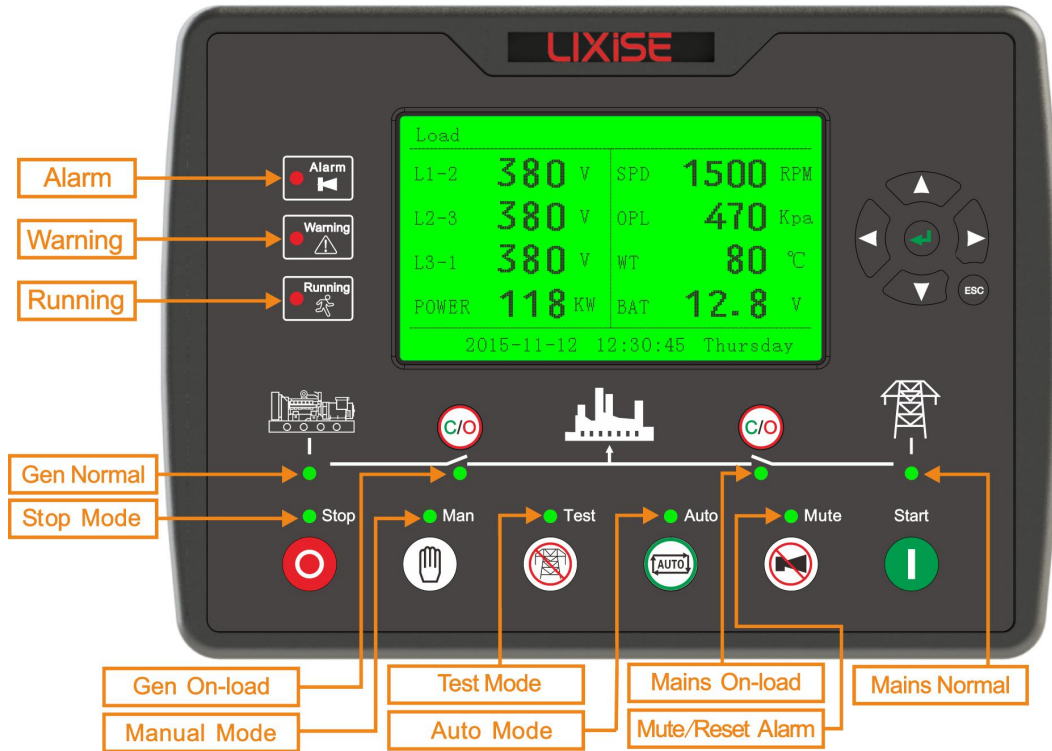

















**1.Indicator light**







## 2. Instruction for the push-buttons

	Stop/Reset	It can let the genset be stopped under the manual / automatic mode. Reset alarm in stop mode; During stopping process, press this button again to stop generator immediately.
	Start	Start genset in Manual mode or Manual Testing mode.
	Manual Mode	Press this key and controller enters in Manual mode.
	Auto Mode	Press this key and controller enters in Auto mode.
	Running With Load	Press this key and controller enters in Manual Testing mode. (except LXC6611)
	Mute/Reset Alarm	1. Eliminate the alarm 2. When a tripping alarm is not stopped, press this button to reset the alarm. But it is not possible to reset other types of alarm
	Gen Closed/Open	Can control generator to switch on or off in manual mode.
	Mains Closed/Open	Can control mains to switch on or off in manual mode.(except LXC6611)
	Confirm	1.press Key can set the parameters 2.press the Key can confirm the parameters 3. Long press this key , can enter the advanced parameter Settings.
	Up/Increase	This key can move up or increase
	Down/Decrease	This key can move down or decrease
	Move left	1. swipe screen 2. Swipe left
	Move right	1. 1. swipe screen 2. Swipe right
	Exit	1.When the screen displays other parameters, press this key to return to the home screen. 2. Press this key can cancel parameter settings that are not confirmed. 3. Long press this button to return to the home screen quickly.

## 3. Parameter setting

**3.1:** Long press  for more than 3 minutes to enter "Input Password" interface,   these two keys can add and subtract numbers,   these two keys can move left or right. After enter the password, press , it will enter the "advanced parameter setting" if the password is correct, otherwise it will exist to the home interface. Initial password is "0000"

**3.2:** The initial password is "0000", the password is modifiable, to prevent others from changing the controller's advanced configuration at random. Please keep in mind after changing the password, if you forget the password, please contact the customer service of the manufacturer. Long press , feedback all the information from the page to the customer service personnel. (detail as follow picture)

**3.3:** Existing the configuration interface, and pressing   at the same time, it can increase the contrast of the LCD screen, and press   at the same time it can decrease the contrast of the LCD screen.

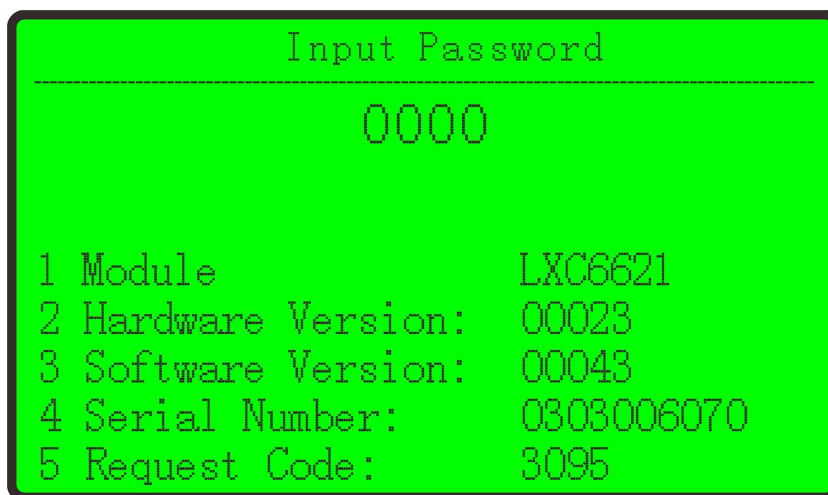

## 4.Adjustable parameters

### New controller usage setting guid:

1. Setting up the ratio of rated current and current transformer
2. Set rated voltage;
3. Set the type of temperature and oil pressure sensor;
4. Set the generator series, set the 1500 speed to 4, and 3000 turn to 2 level.;
5. If you use the speed sensor, you need to set the number of flywheels. The simple way is to choose from the engine menu.

No.	Items	Range	Factory Default	Description	
The timer Settings	1	Start Delay	(0-3600)s	1	Time from the abnormal mains or the remote boot signal to the genset is turned on.
	2	Stop Delay	(0-3600)s	1	Time from normal mains or remote boot signal is invalid to the genset is turned off.
	3	Preheat Delay	(0-300)s	0	Power-on time of heater plug before starter is powered up.
	4	Boot Time	(1-60)s	8	Power-on time of starter.
	5	Boot Interval Time	(3-60)s	10	The waiting time before the second power up when engine boot fail.
	6	Safe running time	(1-60)s	10	Alarms for low oil pressure, high temperature, under speed, under frequency/voltage, charge alt failure are inactive.
	7	Boot Idle time	(0-3600)s	0	Idle running time of genset when starting.
	8	Warming Up Time	(0-3600)s	10	Warming time between genset switch on and high speed running.
	9	Radiating time	(3-3600)s	10	Radiating time before genset stop, after it unloads
	10	Stop Idle Time	(0-3600)s	0	Stop idle time when genset boot .
	11	ETS Solenoid Hold	(0-120)s	20	Stop electromagnet's power on time when genset is stopping.
	12	Waiting time of completing stopping	(0-120)s	0	Time between ending of genset idle delay and stopped when "ETS time" is set as 0; Time between ending of ETS hold delay and stopped when "ETS time" is not 0.
	13	Switch shift delay time	(0-99.9)s	1.0	Interval time from mains switch off to generator switch on; or from generator switch off to mains switch on.
	14	Switch closing pulse delay	(0-100.0)s	5.0	Pulse width of mains/generator switch on.
	15	Open fuel delay	(0-360)s	1.5	
1	Rated Speed	<b>(0-6000RPM)</b>	<b>1500</b>	Offer standard to judge over /under/ loading speed.	
	2	Using speed sensor	Enable / prohibit	Enable	
	3	Flywheel Teeth	<b>(10-300)</b>	<b>118</b>	Tooth number of the engine, for judging of starter crank disconnect conditions and inspecting of engine speed. See the following installation instructions.

Engine setting	4	Automatic calculation of tooth number ( <b>when normal generating</b> )			When the generator is running normally, the number of teeth is automatically calculated by the frequency of the power generation and the rated speed. The specific use method : throught the "confirmation" when the generator is running normally. Reference use guide 5
	5	Boot trial times	<b>(1-10)</b>	<b>3</b>	The number of times that the engine starts at the most unsuccessful boot. When the set number of boot is reached, the controller will send out the boot failure signal.
	6	Engine alarm setting			
	6.1	Speed signal loss delay	(0-20.0)s	3.0	Speed signal loss time delay
	6.2	Speed signal loss action	Warning /Shutdown	Shut down	
	6.3	Overspeed stop threshold	(0-6000)RPM	1710	When the engine speed exceeds this value and lasts for 2S, that means overspeeding, and an overspeed alarm stop signal is issued.
	6.4	Under speed stop threshold	(0-6000)RPM	1200	If the engine speed is lower than this value and lasts for 10s, it is considered to be under speed, an under speed alarm stop signal is issued.
	6.5	Charging failure warning threshold	(0-30)V	6.0	During the normal operation of the genset, the D+ (WL) voltage of the charger is lower than this value and continues. After 5S, the charging failure alarm is sent out. (the return difference is 1V).
	6.6	Battery overvoltage warning threshold	(12-40)V	33.0	When battery voltage exceeds this value and remains for 20s, It will initiate a warning alarm signal. Only warning and not to shutdown the generator. ( <b>Return value is 1V</b> )
	6.7	Battery undervoltage warning threshold	(4-30)V	8.0	When battery voltage has fallen below the set value and remains for 20s, It will initiate a warning alarm signal. Only warning and not to shutdown the generator. ( <b>Return value is 1V</b> )
	6.8	Atuator overvoltage option	Enable / prohibit	enable	
	6.9	Actuator overvoltage threshold	(0-5999)V	55.0	
	6.10	Actuator overvoltage delay	(0-3600)S	2.0	
	7	Separation condition of starting motor			
	Generator settings	7.1	successful start conditions	(0-8)	6
7.2		successful start frequency	(10.0-30.0)Hz	14.0	During the starting process ,when the generator frequency exceeds this value, it means the genset is booted successfully,and the starter will be separated.
7.3		successful start speed	(0-3000)RPM	360	when the engine speed exceeds this value, it means the genset is booted successfully,and the starter will be separated.
7.4		successful start oil pressure	(0-400)kPa	200	when the engine oil pressure exceeds this value, it means the genset is booted successfully,and the starter will be separated
7.5		successful start D+ voltage	(3.0-32.0)V	8	when the engine D+ exceeds this value, it means the genset is booted successfully,and the starter will be separated
1		Gen Rated Volt	(30-620V)	230	Provide reference for overvoltage, undervoltage and load voltage estimation
2		Gen Rated Freq	(10-65Hz)	50	Provide reference for over frequency, under frequency and load frequency estimation.
3		Gen Rated Current	(5-6000)A	500	It refers to the rated current of the generator, which is used to calculate the load overcurrent.
4		Gen Rated Active	(1-59999)Kw	110	
5		Change of current transformer	<b>(5-6000)/5</b>	<b>500</b>	The ratio of the external current transformer.
6		<b>AC power supply mode</b>	<b>(0-3)</b>	<b>0</b>	0 Three phase four wire; 1 Two phase three wire 2 Single phase two wire; 3 Three phase three wire。Detailed function see note 3。
7		Gen Poles	<b>(2-16)</b>	<b>4</b>	

	8	Automatic calculation of polar (when power generation is normal)			
	9	Generator alarm setting			
	9.1	Abnormal generation voltage delay	<b>(0-20.0)s</b>	<b>10</b>	When the generation voltage is too high or too low to alarm delay
	9.2	Overvoltage shutdown protection for power generation	Enable / prohibit	Enable	
	9.3	Overvoltage shutdown threshold of power generation	(30-620)V	262	When the generation voltage is higher than this value and the "power generation abnormal delay" is continuously set, it is means that the generation voltage is too high and the shutdown alarm of abnormal power generation is issued at the same time.
	9.4	Undervoltage shutdown protection for power generation	Enable / prohibit	Enable	
	9.5	Undervoltage shutdown threshold of power generation	(30-620)V	196	When the sampling voltage is lower than this value and the "power generation abnormal delay" is continuously set, it is means that the generation voltage is too low and the shutdown alarm of abnormal power generation is issued at the same time.
	9.6	Over frequency shutdown protection of power generation	Enable / prohibit	Enable	
	9.7	Over frequency shutdown threshold of power generation	(0-75.0)Hz	57.0	When the generator frequency exceeds this value and lasts 2s, that means overfrequency, and the shutdown alarm of overfrequency is issued.
	9.8	Under frequency shutdown protection for power generation	Enable / prohibit	Enable	
	9.9	Over frequency shutdown threshold of power generation	(0-75.0)Hz	45.0	When the generator frequency is lower than this value and is not zero and continuous 10s, that means underfrequency, and the shutdown alarm of underfrequency is issued
	9.10	Excitation overvoltage option	Enable / prohibit	Enable	
	9.11	Excitation overvoltage threshold	(0-5999)V	55.0	
	9.12	Excitation overvoltage delay	(0-3600)S	2	
	10	Overcurrent protection setting			
	10.1	Overcurrent protection threshold	(50-130)%	100.0	When the load current is greater than this percentage, the overcurrent delay begins.
	10.2	Overcurrent protection action	Warning / shutdown / trip stop	<b>stop</b>	
	10.3	Overcurrent delay type	Fixed delay / multiplex delay	Fixed	
	10.4	<b>Overcurrent protection delay</b>	<b>(0-3600)s</b>	<b>30</b>	When the load current and the continuous setting time are greater than the set value it means overcurrent.
Mains settings	1	Rated voltage of mains	(30-620V)	230	Providing benchmarks for overvoltage and undervoltage judgment
	2	Confirmation time of normal mains	(0-3600)s	10	The time is for switching ATS,that when the mains voltage is from abnormal to normal or from normal to abnormal.
	3	Confirmation time of abnormal mains	(0-3600)s	5	
	4	Mains overvoltage alarm	Enable / prohibit	Enable	
	5	Mains overvoltage threshold	(30-620)V	276	When the sampling voltage is higher than this value, it is considered that the mains voltage is too high. The return difference is 10V. (time delay is 1s)
	6	Mains undervoltage alarm	Enable / prohibit	Enable	
	7	Mains undervoltage threshold	(30-620)V	184	When the sampling voltage is lower than this value, it is considered that the mains voltage is too low. The return difference is 10V. (time delay is 1s)

	8	Mains detection	Enable / prohibit	Enable	
The sensor is settings	1	Temperature sensor setting			
	1.1	Selection of temperature sensor	<b>(0-12)</b>	<b>5</b>	<b>SGX</b>
	1.2	<b>Open operation of temperature sensor</b>	<b>No / warning / shutdown</b>	<b>shutdown</b>	The instruction is displayed on the display position of the temperature sensor LCD screen as "+ + +".
	1.3	High water temperature alarm	Enable / prohibit	Enable	
	1.4	High water temperature threshold	(80-140)°C	98	When the temperature value of the external temperature sensor is greater than this value, an excessive temperature signal is issued. This value is only judged after the end of the safety delay. And it is only for the external temperature sensor judgement
	1.5	<b>High water temperature action</b>	Warning / shutdown	shutdown	1. Warning; 2. shutdown
	1.6	Heating option	Enable / prohibit	Prohibit	
	1.7	Heating on threshold	(0-300)°C	50	
	1.8	Heating off threshold	(0-300)°C	55	
	1.9	The longest time of heating	(0-3600)M	60	
	1.10	Custom sensor curve setting	(0-8)		Custom resistance curve
	2	Oil pressure sensor setting			
	2.1	<b>Selection of oil pressure sensor</b>	<b>(0-9)</b>	<b>5</b>	<b>SGX</b>
	2.2	Open operation of oil pressure sensor	<b>No / warning / shutdown</b>	<b>shutdown</b>	The instruction is displayed on the display position of the oil pressure sensor LCD screen as "+ + +".
	2.3	Low oil pressure alarm	Enable / prohibit	Enable	
	2.4	Low oil pressure threshold	(0-400)kPa	103	When the pressure value of the external pressure sensor is less than this value, the oil pressure is too low to delay. This value is judged only after the end of the security delay.
	2.5	Low oil pressure action	Warning / shutdown	shutdown	1. Warning; 2. shutdown
	2.6	Custom sensor curve setting			Custom resistance curve
	3	Liquid level sensor setting			
	3.1	Liquid level sensor option	<b>(0-9)</b>	<b>0</b>	The factory default: Unused
	3.2	<b>Opening action of liquid level sensor</b>	<b>No / warning / shutdown</b>	<b>warning</b>	The instruction is displayed on the display position of the liquid level sensor LCD screen as "+ + +".
	3.3	Low fuel level alarm	Enable / prohibit	Enable	
	3.4	Fuel level low threshold	(0-100)%	10	When the liquid level of the external liquid level sensor is less than this value and lasts 10s,
	3.5	Low fuel level action	<b>Warning / shutdown / trip stop</b>	<b>shutdown</b>	
	3.6	Fuel pump on threshold	(0-100)%	25	When the fuel level is below the set value and lasts for 10s, the fuel pump on signals is outputed.
	3.7	Fuel pump off threshold	(0-100)%	80	When the fuel level is higher than the set value and lasts 10s, the fuel pump off signals is outputed
3.8	Custom sensor curve setting			Custom resistance curve	
4.1	Configurable sensor 1			The factory default: Unused	
5.1	Configurable sensor 2			The factory default: Unused	
Input settings	1	Programmable input port 1 setting			
	1.1	Function selection of programmable input port 1	<b>(0-33)</b>	<b>3</b>	High temperature outage input
	1.2	Effective logic of programmable input port 1	Closure / disconnection	Closure	Closed validity
	2	Programmable input port 2 setting			
	2.1	Function selection of programmable input port 2	<b>(0-33)</b>	<b>4</b>	<b>Low oil pressure outage input</b>
	2.2	Effective logic of programmable input port 2	Closure / disconnection		Effective Closure
	3	Programmable input port 3 setting			

	3.1	Function selection of programmable input port 3	(0-33)	14	Remote booting (load)
	3.2	Effective logic of programmable input port 3	Closure / disconnection		Effective Closure
	4	Programmable input port 4 setting			
	4.1	Function selection of programmable input port 4	(0-33)	7	Low oil level warning input
	4.2	Effective logic of programmable input port 4	Closure / disconnection		Effective Closure
	5	Programmable input port 5 setting			
	5.1	Function selection of programmable input port 5	(0-33)	29	unused
	5.2	Effective logic of programmable input port 5	Closure / disconnection		Effective Closure
	6	Programmable input port 6 setting			
	6.1	Function selection of programmable input port 6	(0-33)	29	unused
	6.2	Effective logic of programmable input port 6	Closure / disconnection		Effective Closure
	7	Programmable input port 7 setting			
	7.1	Function selection of programmable input port 7	(0-33)	29	unused
	7.2	Effective logic of programmable input port 7	Closure / disconnection		Effective Closure
Output settings	1	Function selection of programmable input port 1	(0-93)	16	Factory default: electricity-obtaining stop control
	2	Function selection of programmable input port 2	(0-93)	13	Factory default: Idle speed control
	3	Function selection of programmable input port 3	(0-93)	17	Factory default: Power generation closing output
	4	Function selection of programmable input port 4	(0-93)	20	Factory default: Mains closing output
	5	Function selection of programmable input port 5	(0-31)	0	Factory default: unused.
	6	Function selection of programmable input port 6	(0-31)	0	Factory default: unused.
Scheduling and maintenance settings	1	maintenance 1			Maintenance setting1
	1.1	maintenance 1 alarm	Enable / prohibit	prohibit	
	1.2	maintenance 1 time	(1-5000) H	10	
	1.3	maintenance 1 time to action	Warning / shutdown / trip stop	Warning	
	1.4	Maximum maintenance 1 interval enabling	Enable / prohibit	prohibit	
	1.5	Maximum maintenance 1 interval	(1-24) month	1	
	2	maintenance 2			maintenance setting1
	2.1	maintenance 2 alarm	Enable / prohibit	prohibit	
	2.2	maintenance 2 time	(1-5000) H	10	
	2.3	maintenance 2 time to action	Warning / shutdown / trip stop	prohibit	
	2.4	Maximum maintenance 2 interval enabling	Enable / prohibit	prohibit	
	2.5	Maximum maintenance 2 interval	(1-24) month	1	
	3	maintenance 3			
3.1	maintenance 3 alarm	Enable / prohibit	prohibit		
3.2	maintenance 3 time	(1-5000) H	10		
3.3	maintenance 3 time to action	Warning / shutdown / trip stop	Warning		

	3.4	Maximum maintenance 3 interval enabling	Enable / prohibit	prohibit	
	3.5	Maximum maintenance 3 interval	(1-24) month	1	
	4	Timing booting enable option	Enable / prohibit	prohibit	
	5	Timing boot load option	Load / no load	no load	
	6	Timing boot cycle option	date/week/month	month	
	7	Timing boot 1 setting			
	7.1	Timing boot time (Number of weeks)	(1-5) weeks	1	
	7.2	Timing boot time (week)	(1-7)	7	
	7.3	Timing boot time (clock)	(0-24)	00:00	
	7.4	Running time	(0-30000) min	0	
	8	Timing boot 2 setting			
	8.1	Timing boot time (Number of weeks)	(1-5) w	1	
	8.2	Timing boot time (week)	(1-7)	7	
	8.3	Timing boot time (clock)	(0-24)	00:00	
	8.4	Running time	(0-30000) min	0	
Model Setting	1	Controller information	Factory information		Controller factory information
	2	Language selection	English / Chinese / Spanish / Russian	Chinese	
	3	Selection of power supply mode	(0-2)	0	0: Downtime mode 1: manual mode 2: automatic mode
	4	Pump controller	Enable / prohibit	prohibit	
	5	ATS Controller	Enable / prohibit	prohibit	
	6	Generation detection	Enable / prohibit	Enable	
	7	Forced Start	Enable / prohibit	Enable	
	8	Magnifying display	Enable / prohibit	Enable	
	9	Prohibit load display	Enable / prohibit	prohibit	
	10	Close the power generation forcibly	Enable / prohibit	prohibit	
	11	Sensor 1 Abnormal startup	Enable / prohibit	prohibit	
	12	Sensor 2 Abnormal startup	Enable / prohibit	prohibit	
	13	Screensaver display	Enable / prohibit	prohibit	
	14	Controller address	(1-247)	1	Controller address.
	15	Module date			The module date can be set by users automatically, and the time will be updated automatically after power off.
	16	Module time			Module time, users can set up automatically, and the time will automatically update after power off.
	17	Factory setting	Restore	Restore	Restore the controller to the factory configuration state.
	18	Report the record automatically	Enable / prohibit	Enable	
	19	<b>Time interval of real time recording</b>	<b>(0-3600) S</b>	<b>120</b>	
	20	<b>Fault record time</b>	<b>(0-3600) S</b>	<b>18</b>	
22	Technician password	(0-9999)	0000	Configuration can be viewed and modified.	
23	Operator password	(0-9999)	1111	Only view configuration, no permission to modify.	
24	Negative Display	Enabling/Prohibiting	Prohibit	Load page parameters do not display negative numbers	
25	Abnormal start-up of battery in computer room	Enabling/Prohibiting	Enable	Battery Voltage Abnormal Boot-up ablation in Computer Room	
26	Oil tanker ban	Enabling/Prohibiting	Prohibit	Prohibit automatic mode operation	
27	Starting time of oil tanker ban	(00:00-23:59)	00:00	Disallow automatic mode start time	
28	Turbine Ban End Time	(00:00-23:59)	00:00	Disallow Auto Mode Operation End Time	



30	Time Limitation of Abnormal Generation in Electric Power Environment	Enabling/Prohibiting	Prohibit	Abnormal Generation Time ablation in Electric Power Environment.
31	The longest period of abnormal power generation in electric power environment	(0-59999) min	1	Power environment abnormal operation up to set value shutdown
32	Under voltage alarm enablement	Enabling/Prohibiting	Prohibit	Battery Voltage Under-voltage Alarm Enabling in Computer Room
33	Under voltage warning threshold (1-60V)	(1-60V)	48	Setting of Battery Voltage Under voltage Threshold in Computer Room
34	Under voltage warning delay (0-3600S)	(0-3600S)	10	Time Delay Setting of Battery Voltage Under voltage Warning in Computer Room
35	Under voltage warning return (1-60V)	(1-60V)	53.0	Battery Voltage Under voltage Warning Return Settings in Computer Room
36	Overvoltage alarm enablement	Enabling/Prohibiting	Prohibit	Battery Overvoltage Alarm Enabling in Computer Room
37	Overpressure warning threshold (1-80V)	(1-80V)	58.0	Setting of Battery Voltage Overvoltage Threshold in Computer Room
38	Overvoltage warning delay (0-3600S)	(0-3600S)	0015	Time Delay Setting of Battery Overvoltage Warning in Computer Room
39	Overvoltage warning return (1-80V)	(1-80V)	53	Battery Voltage Overvoltage Warning Return Settings in Computer Room

# 5. Installation

LXC66X1: The controller is designed to be embedded in the panel and fixed by the card when installed. The outline size and the hole size are shown as below.

Outline size: 210mm x 152mm x 46mm

Installation hole size: 186mm x 141mm

## LXC6611 SERIES Typical application diagram

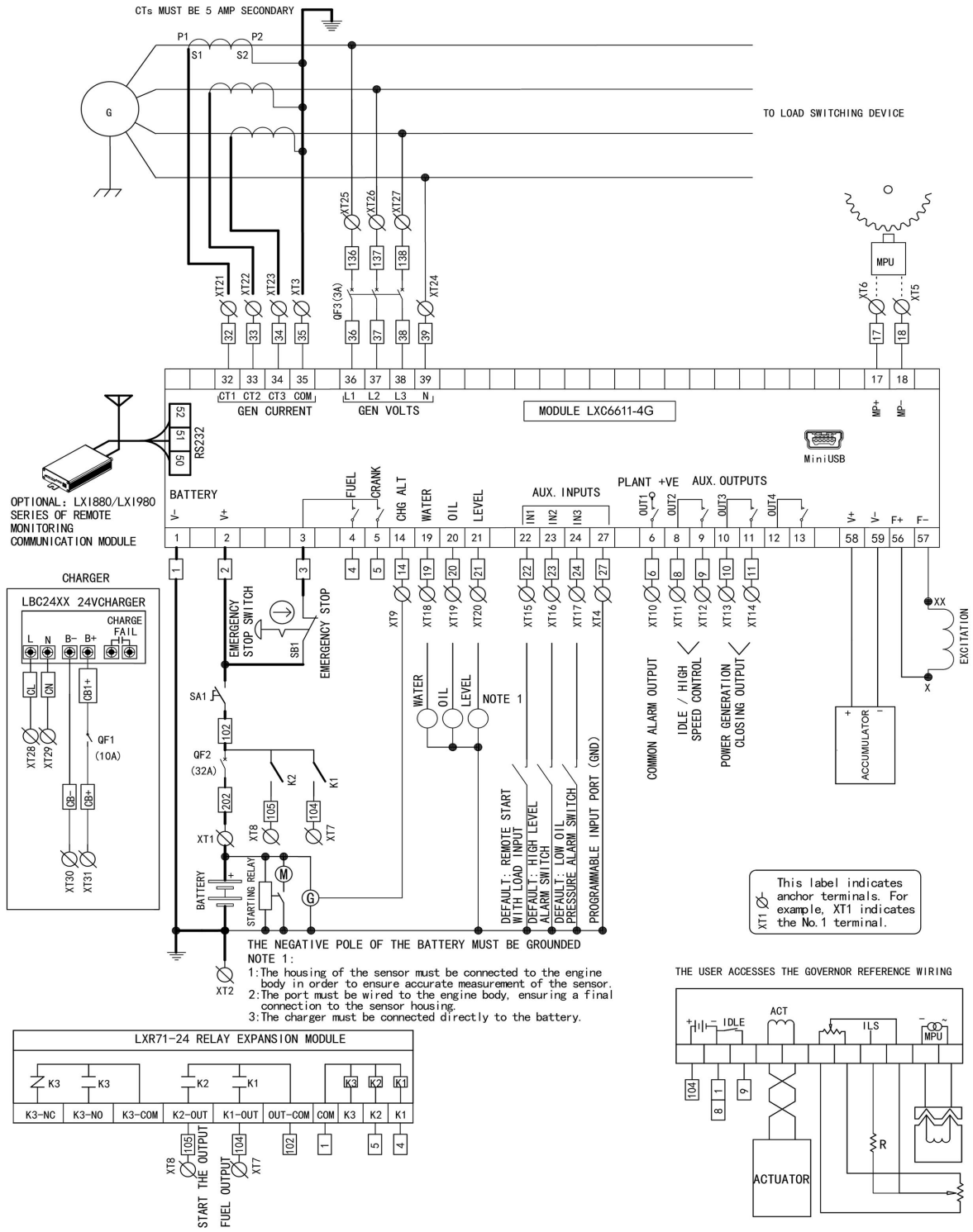

# LXC6621 SERIES Typical application diagram

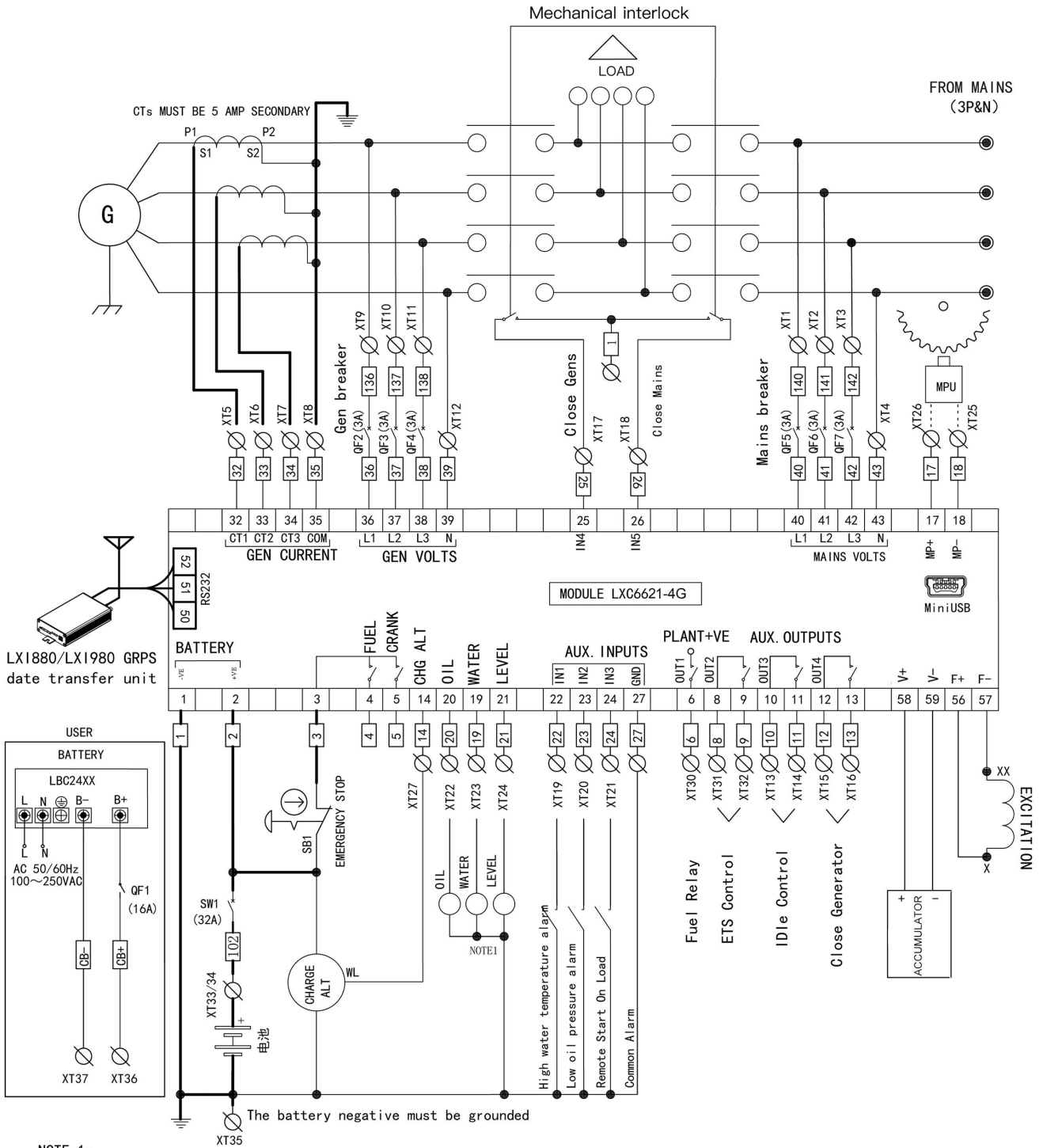

## 6: Model naming rules

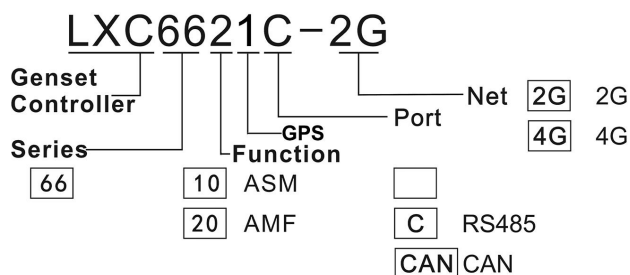

### Attention:

1: When the "communication" position above is not suffix, the controller is the basic type, if you need other suffix instructions, please contact the service personnel.

2: The network band above is default to 2G or 4G/CE. If you need other areas, please agree with the service staff.

Network settings: It can be automatically connected to the cloud service by installing the SIM card. If you need the private cloud service, please contact the service personnel.

Network	Frequency range description
2G	Working frequency: GSM/GPRS 850/900/1800/1900MHz

4G frequency range		4G/E	4G/A	4G/C	4G/CE
LTE	FDD-LTE	B1/ B3/ B5/ B7/ B8/ B20	B2/ B4/ B5/ B12/ B17	B1/ B3/ B8	B1/ B3
	TDD-LTE			B38/ B39/ B40/ B41	B38/ B39/ B40/ B41
3G	WCDMA	B1/ B5/ B8	B2/ B4/ B5	B1/ B8	B1
	TD-SCDMA			B34/39	B34/39
	EVDO/ CDMA2000 1x				BC0
GSM/EDGE		Quad-Band	B2/5	B3/8	B3/8
Region		EMEA, Korea, Thailand, India	America	China (Mobile, Unicom)	China (Mobile / Unicom / Telecom)
Authentication		CE/ GCF/ NCC/ KC/ SKT/ ICASA	FCC	CCC/ SRRC/ CTA	CCC/ SRRC/ CTA

### 6.1 Model comparison

Product Selection Table	LXC 6621-4G	LXC 6611-4G	LXC 6621C-4G	LXC 6611C-4G	LXC 6621CAN-4G	LXC 6611CAN-4G
Switch input port quantity	7	7	7	7	7	7
Relay output port quantity	8	8	8	8	8	8
Sensor quantity	5	5	5	5	5	5
Mains detection	●		●		●	
Cloud service (remote onitoring)	●	●	●	●	●	●
CAN(J1939)					●	●
USB	●	●	●	●	●	●
RS485			●	●	●	●
Real-time Clock	●	●	●	●	●	●
History record	●	●	●	●	●	●
Fault record	●	●	●	●	●	●
Network	2G & 4G	2G & 4G	2G & 4G	2G & 4G	2G & 4G	2G & 4G
GPS	●	●	●	●	●	●